

2級 パターン模範解答
 <名称・地の目線・記号・合い印>

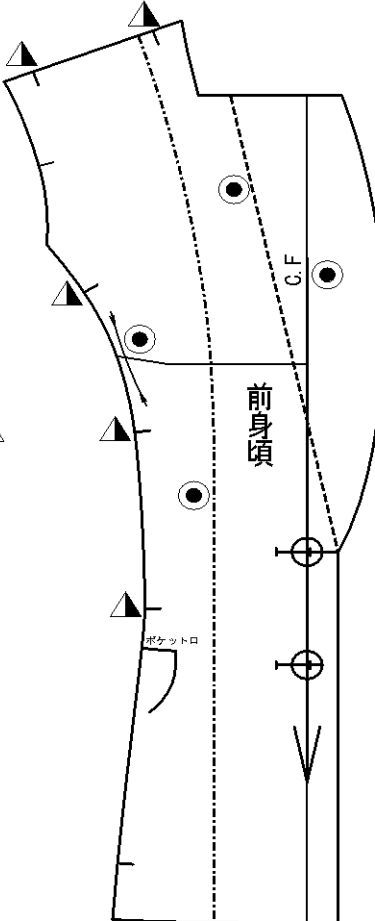

※袖ぐり合印は
1本でも可

※ポケット口は端々まで線が入っていればよい
 (後ろ脇身頃までかからない場合もある)

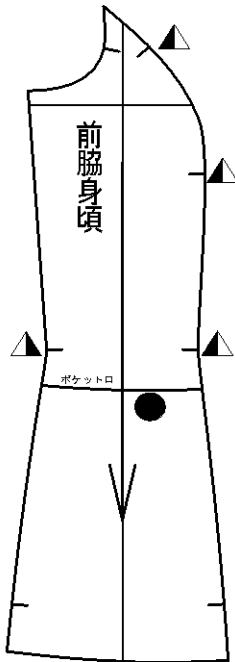
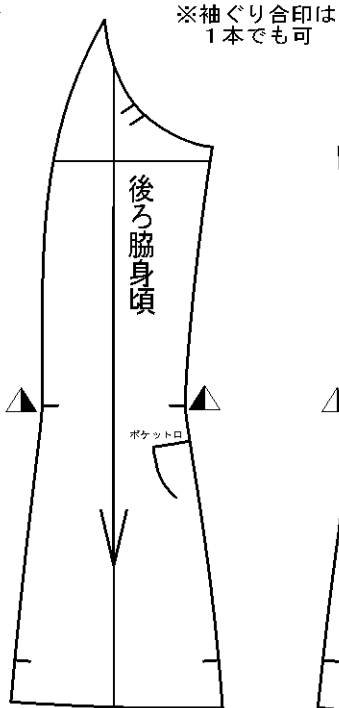
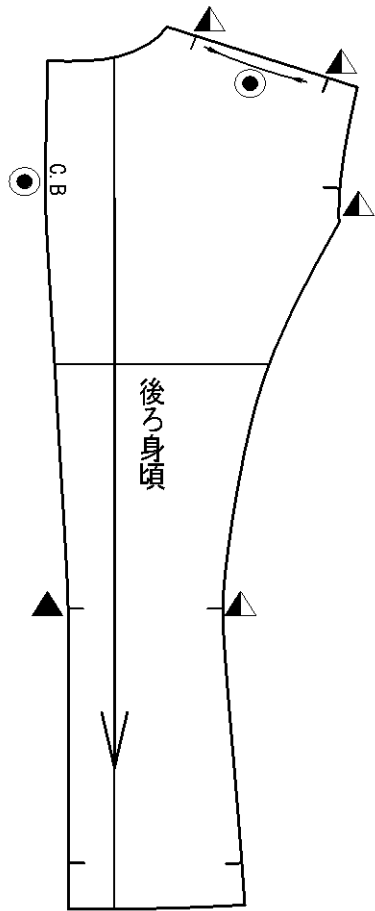
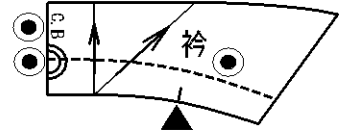
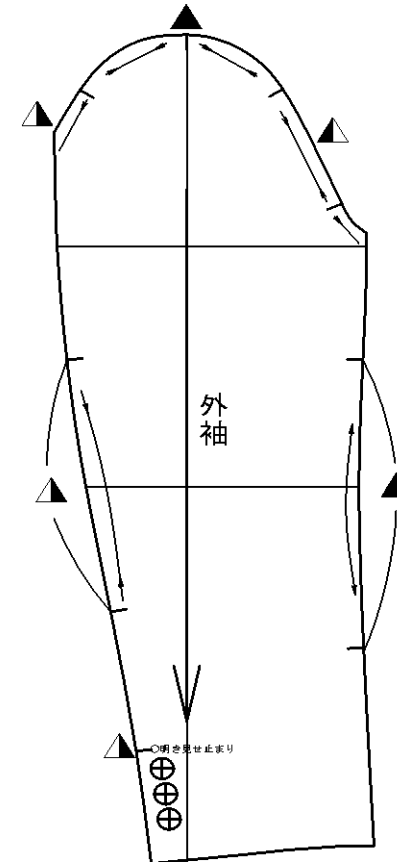
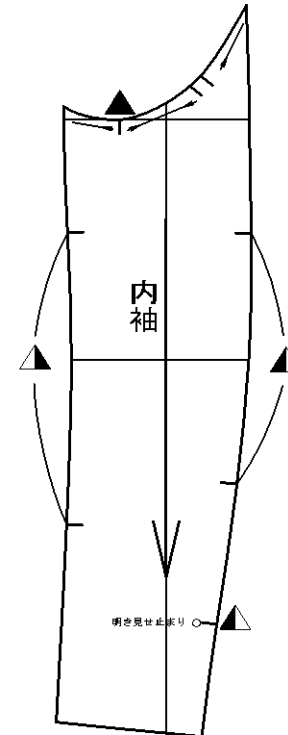
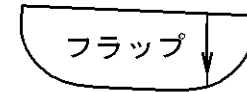

2級 パターン模範解答
 <標準寸法>

